

CATALOGUE



SOFOMARIN : LE SERVICE EN PLUS

UN LARGE CHOIX POUR TOUT SYSTEME DE PLOMBERIE

- **Soudage de pièces en PP & PPG pour plus de compacité**
- **Fabrication de pièces soudées pour des besoins spécifiques**
 - passes coque rallongés pour des coques épaisses
 - raccords annelés spéciaux
 - coudes annelés
 - etc...
- **Livraison en kits pour les productions de série**
 - Ensembles de pièces réunis dans un seul conditionnement
 - Simplifie les opérations d'entrées/sortie
 - Evite les pertes de temps en préparation d'approvisionnement des ateliers
- **Etudes et réalisations d'ensembles sur mesure**
 - Manifold pour les remplissages, vidanges, transferts de ballasts livré monté, prêt à raccorder
 - Collecteur équipés de vannes
 - Clarinettes d'assèchement
 - Etc...
- **Motorisation de vanne**
 - Pour toute fonction répétitive comme les transferts de ballasts
 - Basse tension 12 ou 24 V CC



REALISATION DE RESERVOIRS SUR MESURE INOX ET ALU

Réservoir eau douce en inox ou aluminium

toutes dimensions
équipé de tout ses raccords
testé en pression

Réservoir Carburant en inox ou aluminium

toutes dimensions
équipé de tout ses raccords
testé en pression
Conforme CE

Holding Tank en inox ou aluminium

toutes dimensions
équipé de tout ses raccords
testé en pression

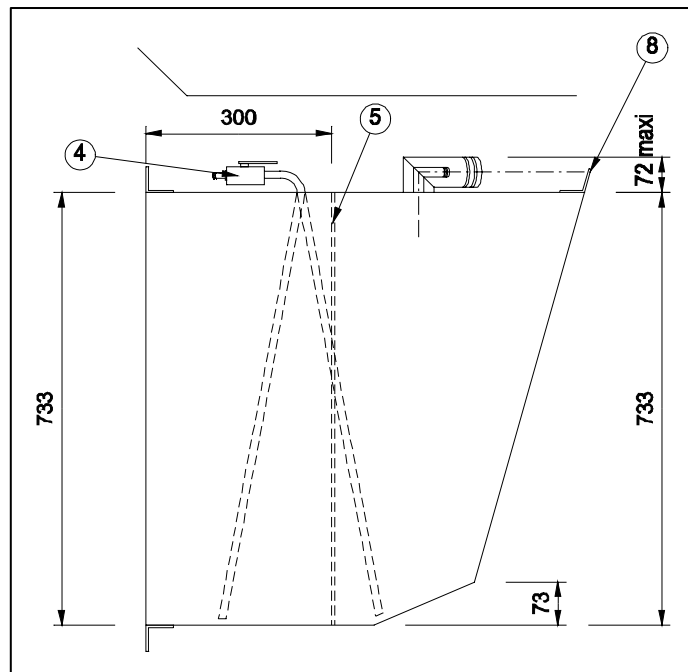

VANNE ECOPE VENTURY

Une exclusivité brevetée SOFOMARIN

Maniement facile, la *Sofo Scoop* se pose comme une vanne classique



Une seule vanne ! Trois fonctions

La *Sofo Scoop*

- 1- Ecope
- 2- VENTURY
- 3- Obstrue

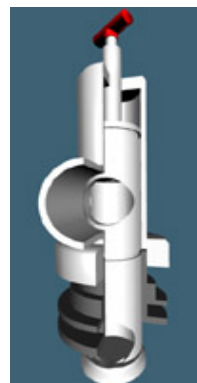

Cette vanne est un élément qui a trois fonctions :

Remplir les ballasts

Par la vitesse propre du bateau ou s'il y a une hauteur importante à monter elle aide au fonctionnement d'une pompe manuelle ou électrique.

Vider les ballasts

Par la vitesse, l'eau est évacuée par effet "ventury" et utilise le même circuit que le remplissage. Ceci évite des systèmes complexes de tuyauteries et des surcharges de poids. C'est aussi une simplification du système de manœuvre réduisant le nombre de vannes.

Fermer les ballasts

La fermeture est obtenue par l'obturation de la vanne en tirant le système de fonction. Il assure l'étanchéité.

Manœuvre : La Sofo scoop n'a qu'une seule manœuvre pour obtenir le fonctionnement soit par rotation de l'axe, soit par déplacement longitudinal de l'axe de la vanne.

EXISTE EN 3 DIMENSIONS

SOFOSCOOP1 DN 25
SOFOSCOOP2 DN 40
SOFOSCOOP3 DN 50

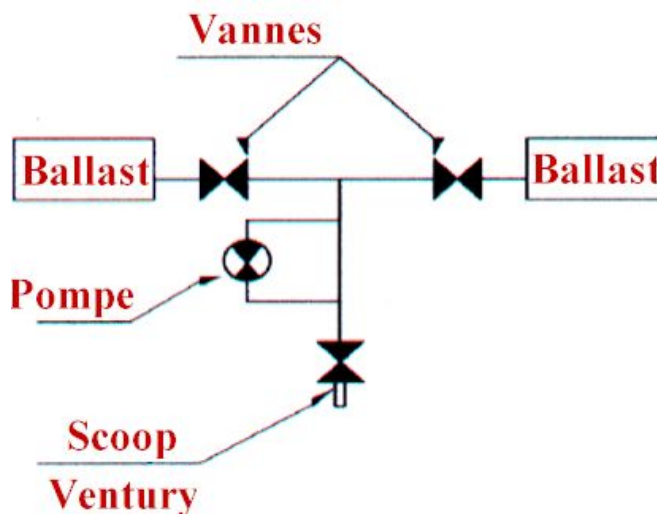

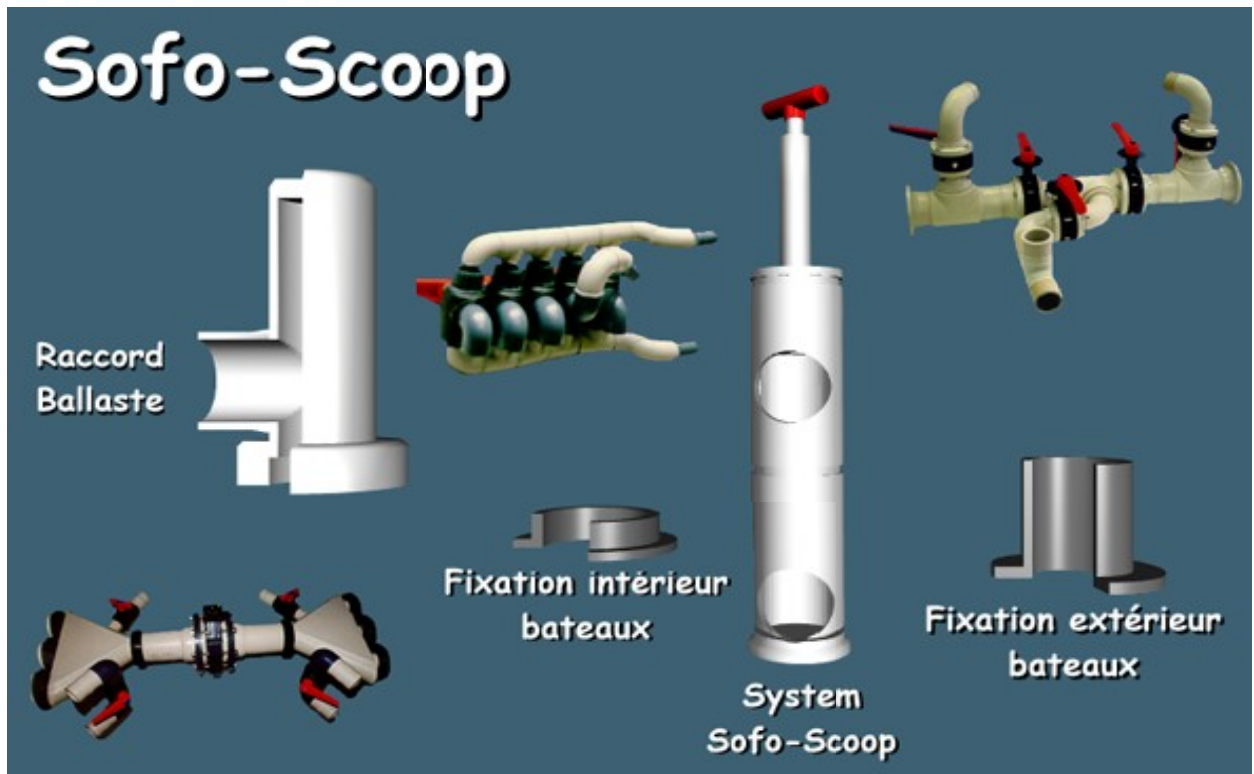

LA SOFO SCOOP est présente sur:

LES "MINI -TRANSAT"
LES "FIGARO"
LES 50' OPEN
LES 60' OPEN
LES TRIMARARNS 60' OPEN
"THE RACE"
LES NOUVEAUX 120', 130' 140' CARBONE

VANNES PPG HOMOLOGUES VERITAS

ROBINETS A BOISSEAU SPHERIQUE EN PPG (Polypropylene chargé fibre de verre)
JOINTS EPDM

ROBINETS UNION		G
RXU015	RBS 2 UNIONS DN15	1/2"
RXU020	RBS 2 UNIONS DN20	3/4"
RXU025	RBS 2 UNIONS DN 25	1"
RXU032	RBS 2 UNIONS DN32	1"1/4
RXU040	RBS 2 UNIONS DN40	1"1/2
RXU050	RBS 2 UNIONS DN50	2"
RXU065	RBS 2 UNIONS DN65	2"1/2
RXU080	RBS 2 UNIONS DN80	3"
RXU100	RBS 2 UNIONS DN 110	4"



ROBINETS UNION 3 VOIES		G
RXU315	RBS 2 UNIONS 3 VOIES DN15	1/2"
RXU320	RBS 2 UNIONS 3 VOIES DN20	3/4"
RXU325	RBS 2 UNIONS 3 VOIES DN25	1"
RXU332	RBS 2 UNIONS 3 VOIES DN32	1"1/4
RXU340	RBS 2 UNIONS 3 VOIES DN40	1"1/2
RXU350	RBS 2 UNIONS 3 VOIES DN50	2"



ROBINETS COMPACT DROIT		G
RXVD15	RBS 2 VOIES DN15	1/2"
RXVD20	RBS 2 VOIES DN20	3/4"
RXVD25	RBS 2 VOIES DN25	1"
RXVD32	RBS 2 VOIES DN32	1"1/4
RXVD40	RBS 2 VOIES DN40	1"1/2
RXVD50	RBS 2 VOIES DN50	2"
RXVWCB	RBS 2 VOIES DN50 blanc spécial WC	2"



ROBINETS COMPACTS D'EQUERRE		G
RXVE15	RBS 2 VOIES EQUERRE DN 15	1/2"
RXVE20	RBS 2 VOIES EQUERRE DN20	3/4"
RXVE25	RBS 2 VOIES EQUERRE DN25	1"
RXVE32	RBS 2 VOIES EQUERRE DN32	1"1/4
RXVE40	RBS 2 VOIES EQUERRE DN40	1"1/2
RXVE50	RBS 2 VOIES EQUERRE DN50	2"



ROBINETS COMPACTS 3 VOIES		G
RXV315	RBS 3 VOIES DN15	1/2"
RXV320	RBS 3 VOIES DN20	3/4"
RXV325	RBS 3 VOIES DN25	1"
RXV332	RBS 3 VOIES DN32	1"1/4
RXV340	RBS 3 VOIES DN40	1"1/2
RXV350	RBS 3 VOIES DN50	2"



Possibilité d'équiper ces robinets avec des joints nitriles pour le gazoil.

RXVF15	RBS 2 VOIES FUEL DN15	1/2"
--------	-----------------------	------

VANNES PAPILLON PPG

VANNES PAPILLON SANDWICH		G
RXPO65	VANNE PAPILLON DN65	2"1/2
RXPO80	VANNE PAPILLON DN80	3"
RXPO100	VANNE PAPILLON DN100	4"



CLAPETS ANTI RETOUR PPG

CLAPETS ANTI RETOUR		G
RX2U15	CLAPET AR UNION DN 15	1/2"
RX2U20	CLAPET AR UNION DN 20	3/4"
RX2U25	CLAPET AR UNION DN 25	1"
RX2U32	CLAPET AR UNION DN 32	1"1/4
RX2U40	CLAPET AR UNION DN 40	1"1/2
RX2U50	CLAPET AR UNION DN50	2"



RXCL15	CLAPET AR DN 15	1/2"
RXCL20	CLAPET AR DN 20	3/4"
RXCL25	CLAPET AR DN 25	1"
RXCL32	CLAPET AR DN 32	1"1/4
RXCL40	CLAPET AR DN 40	1"1/2
RXCL50	CLAPET AR DN50	2"



PASSAGES DE COQUE PPG

(Polypropylène chargé fibre de verre)

BONDES DE FOND (passes coque fraisés) BLANCHES		G
RXBO15B	BONDE DE FOND BLANCHE	1/2"
RXBO20B	BONDE DE FOND BLANCHE	3/4"
RXBO25B	BONDE DE FOND BLANCHE	1"
RXBO32B	BONDE DE FOND BLANCHE	1"1/4
RXBO40B	BONDE DE FOND BLANCHE	1"1/2
RXBO50B	BONDE DE FOND BLANCHE	2"

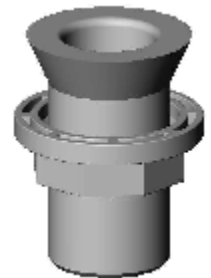

PASSES COQUE A COLLERETTE A JOINT TORIQUE		G
RXPC15	PASSE COQUE NOIR	1/2'
RXPC20	PASSE COQUE NOIR	3/4"
RXPC25	PASSE COQUE NOIR	1"
RXPC32	PASSE COQUE NOIR	1"1/4
RXPC40	PASSE COQUE NOIR	1"1/2
RXPC50	PASSE COQUE NOIR	2"
RXPCB15	PASSE COQUE BLANC	1/2'
RXPCB20	PASSE COQUE BLANC	3/4"
RXPCB25	PASSE COQUE BLANC	1"
RXPCB32	PASSE COQUE BLANC	1"1/4
RXPCB40	PASSE COQUE BLANC	1"1/2
RXPCB50	PASSE COQUE BLANC	2"

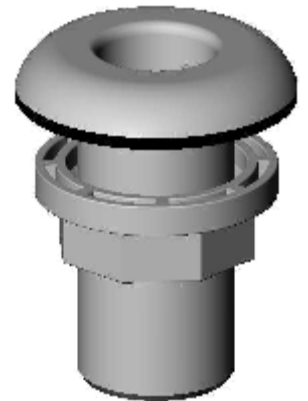

PASSES COQUE A JOINT PLAT EPDM		G
RXPCEPDM15	PASSE COQUE A JOINT PLAT EPDM NOIR	1/2'
RXPCEPDM20	PASSE COQUE A JOINT PLAT EPDM NOIR	3/4"
RXPCEPDM25	PASSE COQUE A JOINT PLAT EPDM NOIR	1"
RXPCEPDM32	PASSE COQUE A JOINT PLAT EPDM NOIR	1"1/4
RXPCEPDM40	PASSE COQUE A JOINT PLAT EPDM NOIR	1"1/2
RXPCEPDM50	PASSE COQUE A JOINT PLAT EPDM NOIR	2"

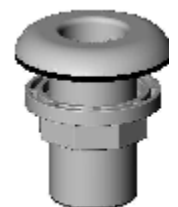

Etanchéité assurée par un joint plat en EPDM

BOUCHONS MÂLES ET FEMELLES PPG

BOUCHONS FEMELLES		G
RXBF15	BOUCHON F	1/2"
RXBF20	BOUCHON F	3/4"
RXBF25	BOUCHON F	1"
RXBF32	BOUCHON F	1"1/4
RXBF40	BOUCHON F	1"1/2
RXBF50	BOUCHON F	2"
RXBF75	BOUCHON F	3"



Permettent d'obturer un passe coque pendant les opérations de maintenance à flot

BOUCHONS MÂLES		G
RXBM10	BOUCHON M	3/8"
RXBM15	BOUCHON M	1/2"
RXBM20	BOUCHON M	3/4"
RXBM25	BOUCHON M	1"
RXBM32	BOUCHON M	1"1/4
RXBM40	BOUCHON M	1"1/2
RXBM50	BOUCHON M	2"



RACCORDS ANNELES PPG

RACCORDS DROITS ANNELES MÂLES		Ø	G
RXRM07	RACCORD DROIT M	7	1/4"
RXRM08	RACCORD DROIT M	12	1/4"
RXRM10	RACCORD DROIT M	12	3/8"
RXRM11	RACCORD DROIT M	16	3/8"
RXRM14	RACCORD DROIT M	13	1/2"
RXRM15	RACCORD DROIT M	16	1/2"
RXRM16	RACCORD DROIT M	20	1/2"
RXRM18	RACCORD DROIT M	12	3/4"
RXRM19	RACCORD DROIT M	16	3/4"
RXRM20	RACCORD DROIT M	20	3/4"
RXRM21	RACCORD DROIT M	25	3/4"
RXRM24	RACCORD DROIT M	20	1"
RXRM25	RACCORD DROIT M	25	1"
RXRM26	RACCORD DROIT M	32	1"
RXRM31	RACCORD DROIT M	25	1"1/4
RXRM32	RACCORD DROIT M	32	1"1/4
RXRM33	RACCORD DROIT M	40	1"1/4
RXRM34	RACCORD DROIT M	38	1"1/4
RXRM35	RACCORD DROIT M	35	1"1/4
RXRM38	RACCORD DROIT M	38	1"1/2
RXRM40	RACCORD DROIT M	40	1"1/2
RXRM41	RACCORD DROIT M	50	1"1/2
RXRM50	RACCORD DROIT M	50	2"
RXRM51	RACCORD DROIT M	60	2"



RACCORDS DROITS ANNELES FEMELLES		Ø	G
RXRF12	RACCORD DROIT F	12	3/8"
RXRF14	RACCORD DROIT F	13	1/2"
RXRF15	RACCORD DROIT F	16	1/2"
RXRF18	RACCORD DROIT F	12	3/4"
RXRF19	RACCORD DROIT F	16	3/4"
RXRF20	RACCORD DROIT F	20	3/4"
RXRF24	RACCORD DROIT F	20	1"
RXRF25	RACCORD DROIT F	25	1"
RXRF31	RACCORD DROIT F	25	1"1/4
RXRF32	RACCORD DROIT F	32	1"1/4
RXRF40	RACCORD DROIT F	40	1"1/2
RXRF50	RACCORD DROIT F	50	2"



COUDES ANNELES FEMELLES		Ø	G
RXCC15	COUDE F	12	1/2"
RXCC19	COUDE F	16	3/4"
RXCC20	COUDE F	20	3/4"
RXCC25	COUDE F	25	1"
RXCC31	COUDE F	25	1"1/4
RXCC32	COUDE F	32	1"1/4
RXCC40	COUDE F	40	1"1/2
RXCC50	COUDE F	50	2"



COUDES ANNELES MÂLES		Ø	G
RXCO12	COUDE M	12	3/8"
RXCO14	COUDE M	12	1/2"
RXCO15	COUDE M	16	1/2"
RXCO16	COUDE M	20	1/2"
RXCO20	COUDE M	20	3/4"
RXCO21	COUDE M	25	3/4"
RXCO25	COUDE M	25	1"
RXCO26	COUDE M	32	1"
RXCO32	COUDE M	32	1"1/4
RXCO40	COUDE M	40	1"1/2



RACCORDS A VISSER PPG

RACCORDS UNION		G
RXUN25	RACCORD UNION DN25	1"
RXUN32	RACCORD UNION DN32	1"1/4
RXUN40	RACCORD UNION DN 40	1"1/2
RXUN50	RACCORD UNION DN50	2"



COUDES FEMELLE/FEMELLE		G
RXCF10	COUDE F/F	3/8"
RXCF15	COUDE F/F	1/2"
RXCF20	COUDE F/F	3/4"
RXCF25	COUDE F/F	1"
RXCF32	COUDE F/F	1"1/4
RXCF40	COUDE F/F	1"1/2
RXCF50	COUDE F/F	2"



COUDES MÂLE/ FEMELLE		G
RXCM15	COUDE M/F	1/2"
RXCM20	COUDE M/F	3/4"
RXCM25	COUDE M/F	1"

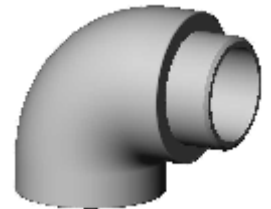

MANCHONS FEMELLE/FEMELLE		G
RXMA10	MANCHON F/F	3/8"
RXMA15	MANCHON F/F	1/2"
RXMA20	MANCHON F/F	3/4"
RXMA25	MANCHON F/F	1"
RXMA32	MANCHON F/F	1"1/4
RXMA40	MANCHON F/F	1"1/2
RXMA50	MANCHON F/F	2"

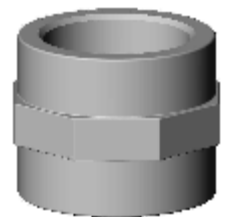

MANCHONS REDUITS FEMELLE/FEMELLE		G	G
RXMI20	MANCHON REDUIT F/F	3/4"	1/2"
RXMI25	MANCHON REDUIT F/F	1"	3/4"
RXMI32	MANCHON REDUIT F/F	1"1/4	1"
RXMI40	MANCHON REDUIT F/F	1"1/2	1"1/4
RXMI50	MANCHON REDUIT F/F	2"	1"1/2

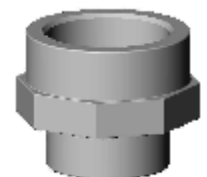

REDUCTIONS MÂLE/ FEMELLE		G	G
RXRMF15	REDUCTION M/F	1/2"	3/8"
RXRMF20	REDUCTION M/F	3/4"	1/2"
RXRMF25	REDUCTION M/F	1"	3/4"
RXRMF32	REDUCTION M/F	1"1/4	1"
RXRMF40	REDUCTION M/F	1"1/2	1"1/4
RXRMF50	REDUCTION M/F	2"	1"1/2

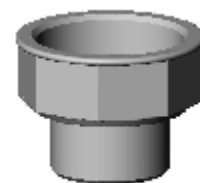

MAMELONS MÂLE/ MÂLE		G
RXMM10	MAMELON M/M	3/8"
RXMM15	MAMELON M/M	1/2"
RXMM20	MAMELON M/M	3/4"
RXMM25	MAMELON M/M	1"
RXMM32	MAMELON M/M	1"1/4
RXMM40	MAMELON M/M	1"1/2
RXMM50	MAMELON M/M	2"

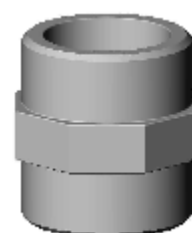

MAMELONS REDUITS MÂLE/ MÂLE		G	G
RXMR15	MAMELON REDUIT M/M	1/2"	3/8"
RXMR20	MAMELON REDUIT M/M	3/4"	1/2"
RXMR25	MAMELON REDUIT M/M	1"	3/4"
RXMR32	MAMELON REDUIT M/M	1"1/4	1"
RXMR40	MAMELON REDUIT M/M	1"1/2	1"1/4
RXMR50	MAMELON REDUIT M/M	2"	1"1/2

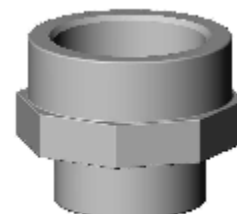

TES FEMELLE/FEMELLE/FEMELLE		G
RXTE10	TE F/F/F	3/8"
RXTE15	TE F/F/F	1/2"
RXTE20	TE F/F/F	3/4"
RXTE25	TE F/F/F	1"
RXTE32	TE F/F/F	1"1/4
RXTE40	TE F/F/F	1"1/2
RXTE50	TE F/F/F	2"

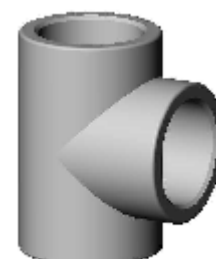

RACCORDS PLASTIQUES

SORTIE DE COQUE DROITE			G
PCNY15	PASSE COQUE NYLON	16	5/8"
PCNY20	RACCORD DROIT M	19	3/4"
PCNY25	RACCORD DROIT M	25	1"
PCNY38	RACCORD DROIT M	38	1"1/2



SORTIE DE COQUE COUDEE			G
PCCD20	RACCORD DROIT M	19	3/4"
PCCD25	RACCORD DROIT M	25	1"
PCCD38	RACCORD DROIT M	38	1"1/2



RACCORDS Y CANNELES RILSAN		Ø	Ø	Ø
Y08	Raccord Y cannelé rilsan	8	8	8
Y10	Raccord Y cannelé rilsan	10	10	10
Y12	Raccord Y cannelé rilsan	12	12	12
Y14	Raccord Y cannelé rilsan	14	14	14
Y16	Raccord Y cannelé rilsan	16	16	16



RACCORDS en T CANNELES RILSAN		Ø	Ø	Ø
TE12	Raccord Y cannelé rilsan	12	12	12
TE14	Raccord Y cannelé rilsan	14	14	14
TE16	Raccord Y cannelé rilsan	16	16	16
TE20	Raccord Y cannelé rilsan	20	20	20
TE25	Raccord Y cannelé rilsan	25	25	25



RACCORDS REDUIT en T CANNELES RILSAN		Ø	Ø	Ø
TERED2016	Té cannelé rilsan réduit	20	16	20
TERED2516	Té cannelé rilsan réduit	25	16	25
TERED2520	Té cannelé rilsan réduit	25	20	25
TERED3220	Té cannelé rilsan réduit	32	20	32
TERED3225	Té cannelé rilsan réduit	32	25	32
TERED4020	Té cannelé rilsan réduit	40	20	40
TERED4032	Té cannelé rilsan réduit	40	32	40



FILTRES PPG

FILTRES A TAMIS		G
RXFI15	FILTRE DN 15	1/2"
RXFI20	FILTRE DN 20	3/4"
RXFI25	FILTRE DN25	1"
RXFI32	FILTRE DN32	1"1/4
RXFI40	FILTRE DN 40	1"1/2
RXFI50	FILTRE DN50	2"



ELEMENTS DE RECHANGE DES FILTRES A TAMIS	
TAMI INOX	FILTRES A TAMIS
RXTA20	RXFI15
	RXFI20
	RXFI25
RXTA40	RXFI32
	RXFI40
	RXFI50



CREPINES PPG

CREPINES FEMELLES		G
RXCRF25	CREPINE SEULE F	1"
RXCRF32	CREPINE SEULE F	1"1/4
RXCRF40	CREPINE SEULE F	1"1/2
RXCRF50	CREPINE SEULE F	2"



CREPINES MÂLES		G
RXCRM15	CREPINE SEULE M	1/2"
RXCRM20	CREPINE SEULE M	3/4"



RACCORDS SPECIAUX PPG

RACCORDS RAPIDES A CAME		G
RXXBC40	BOUCHON COUPLEUR DN 40	1"1/2
RXXBF40	BOUCHON RACCORD A CAMES DN 40	1"1/2
RXXCM40	ADAPTATEUR ANNELE DN 40	1"1/2
RXXFC40	COUPLEUR ANNELE DN 40	1"1/2
RXXFF40	COUPLEUR TARAUDE F/F DN 40	1"1/2
RXXFM40	ADAPTATEUR TARAUDE DN 40	1"1/2
RXXMF40	COUPLEUR FILETE DN40	1"1/2



VANNES ET ROBINETS BRONZE ET LAITON

INOX: NOUS CONSULTER

ROBINETS A BOISSEAU SPHERIQUE LAITON F/F		G
V61208	ROBINET RBS SPH DN 08	1/4"
V61210	ROBINET RBS SPH DN 10	3/8"
V61215	ROBINET RBS SPH DN 15	1/2"
V61220	ROBINET RBS SPH DN 20	3/4"
V61225	ROBINET RBS SPH DN 25	1"
V61232	ROBINET RBS SPH DN 32	1"1/4
V61240	ROBINET RBS SPH DN 40	1"1/2
V61250	ROBINET RBS SPH DN 50	2"
V61260	ROBINET RBS SPH DN 60	2"1/2
V61275	ROBINET RBS SPH DN 75	3"



ROBINETS A BOISSEAU SPHERIQUE LAITON M/M		G
V63208	ROBINET RBS SPH DN 08	1/4"
V63210	ROBINET RBS SPH DN 10	3/8"
V63215	ROBINET RBS SPH DN 15	1/2"
V63220	ROBINET RBS SPH DN 20	3/4"
V63225	ROBINET RBS SPH DN 25	1"
V63232	ROBINET RBS SPH DN 32	1"1/4
V63240	ROBINET RBS SPH DN 40	1"1/2
V63250	ROBINET RBS SPH DN 50	2"



ROBINETS A BOISSEAU SPHERIQUE LAITON M/F		G
V65208	ROBINET RBS SPH DN 08	1/4"
V65210	ROBINET RBS SPH DN 10	3/8"
V65215	ROBINET RBS SPH DN 15	1/2"
V65220	ROBINET RBS SPH DN 20	3/4"
V65225	ROBINET RBS SPH DN 25	1"
V65232	ROBINET RBS SPH DN 32	1"1/4
V65240	ROBINET RBS SPH DN 40	1"1/2
V65250	ROBINET RBS SPH DN 50	2"



ROBINETS A BOISSEAU SPHERIQUE 3 VOIES laiton en T		G
V4T308T	VANNE 3 VOIES EN T	1/4"
V4T310T	VANNE 3 VOIES EN T	3/8"
V4T315T	VANNE 3 VOIES EN T	1/2"
V4T325T	VANNE 3 VOIES EN T	1"
V4T332T	VANNE 3 VOIES EN T	1"1/4
V4T340T	VANNE 3 VOIES EN T	1"1/2
V4T350T	VANNE 3 VOIES EN T	2"



ROBINETS A BOISSEAU SPHERIQUE 3 VOIES laiton en L		G
V4T308	VANNE 3 VOIES EN L	1/4"
V4T310	VANNE 3 VOIES EN L	3/8"
V4T315	VANNE 3 VOIES EN L	1/2"
V4T320	VANNE 3 VOIES EN L	3/4"
V4T325	VANNE 3 VOIES EN L	1"
V4T332	VANNE 3 VOIES EN L	1"1/4
V4T340	VANNE 3 VOIES EN L	1"1/2



VANNES A FERMETURE RAPIDE LAITON		G
VAFR10	VANNE A FERMETURE RAPIDE	3/8"
VAFR15	VANNE A FERMETURE RAPIDE	1/2"
VAFR20	VANNE A FERMETURE RAPIDE	3/4"
VAFR25	VANNE A FERMETURE RAPIDE	1"
VAFR32	VANNE A FERMETURE RAPIDE	1"1/4
VAFR40	VANNE A FERMETURE RAPIDE	1"1/2



VANNES A OPERCULE LAITON		G
VOPD08	VANNE LAITON A OPERCULE DN 08	1/4"
VOPD10	VANNE LAITON A OPERCULE DN 10	3/8"
VOPD15	VANNE LAITON A OPERCULE DN 15	1/2"
VOPD20	VANNE LAITON A OPERCULE DN 20	3/4"
VOPD25	VANNE LAITON A OPERCULE DN 25	1"
VOPD32	VANNE LAITON A OPERCULE DN 32	1"1/4
VOPD40	VANNE LAITON A OPERCULE DN 40	1"1/2
VOPD50	VANNE LAITON A OPERCULE DN 50	2"
VOPD60	VANNE LAITON A OPERCULE DN 60	2"1/2
VOPD75	VANNE LAITON A OPERCULE DN 70	3"



ROBINETS FERMETURE RAPIDE LAITON		G
VN1710	ROBINET FERMETURE RAPIDE F/F DN10	3/8"
VN1715	ROBINET FERMETURE RAPIDE F/F DN15	1/2"



PASSES COQUE LAITON

PASSES COQUE A COLLERETTE		G
PC10	PASSE COQUE LAITON	3/8"
PC15	PASSE COQUE LAITON	1/2"
PC20	PASSE COQUE LAITON	3/4"
PC25	PASSE COQUE LAITON	1"
PC32	PASSE COQUE LAITON	1"1/4"
PC40	PASSE COQUE LAITON	1"1/2"
PC50	PASSE COQUE LAITON	2"
PC75	PASSE COQUE LAITON	3"



PASSES COQUE EMBOUT ANNELE		G
PCA10	PASSE COQUE EMBOUT ANNELE	3/8"
PCA15	PASSE COQUE EMBOUT ANNELE	1/2"
PCA20	PASSE COQUE EMBOUT ANNELE	3/4"
PCA25	PASSE COQUE EMBOUT ANNELE	1"



PRISE EAU DE MER AVEC CREPINE		G
PCCR10	PRISE D'EAU DE MER	3/8"
PCCR15	PRISE D'EAU DE MER	1/2"
PCCR20	PRISE D'EAU DE MER	3/4"
PCCR25	PRISE D'EAU DE MER	1"
PCCR32	PRISE D'EAU DE MER	1"1/4"
PCCR40	PRISE D'EAU DE MER	1"1/2"
PCCR50	PRISE D'EAU DE MER	2"



RACCORDS ANNELES LAITON

RACCORDS ANNELES FEMELLES		Ø	G
CALF08	RACCORD PTR CAN F	8	1/4"
CALF10	RACCORD PTR CAN F	10	3/8"
CALF15	RACCORD PTR CAN F	16	1/2"
CALF20	RACCORD PTR CAN F	20	3/4"
CALF25	RACCORD PTR CAN F	25	1"
CALF26	RACCORD PTR CAN F	30	1"
CALF32	RACCORD PTR CAN F	32	1"1/4
CALF40	RACCORD PTR CAN F	40	1"1/2
CALF50	RACCORD PTR CAN F	50	2"



RACCORDS ANNELES FEMELLES 1 pièce		Ø	G
CAF10	RACCORD PTR CAN F	10	3/8"
CAF15	RACCORD PTR CAN F	16	1/2"
CAF20	RACCORD PTR CAN F	20	3/4"
CAF25	RACCORD PTR CAN F	25	1"
CAF32	RACCORD PTR CAN F	32	1"1/4
CAF38	RACCORD PTR CAN F	38	1"1/2
CAF40	RACCORD PTR CAN F	40	1"1/2
CAF50	RACCORD PTR CAN F	50	2"



RACCORDS ANNELES MÂLES		Ø	G
CALA05	RACCORD PTR CAN M	5	6/9"
CALA07	RACCORD PTR CAN M	7,5	1/4"
CALA08	RACCORD PTR CAN M	8	1/4"
CALA09	RACCORD PTR CAN M	8	3/8"
CALA10	RACCORD PTR CAN M	10	3/8"
CALA12	RACCORD PTR CAN M	12	3/8"
CALA14	RACCORD PTR CAN M	15	3/8"
CALA15	RACCORD PTR CAN M	16	1/2"
CALA16	RACCORD PTR CAN M	20	1/2"
CALA20	RACCORD PTR CAN M	20	3/4"
CALA21	RACCORD PTR CAN M	25	3/4"
CALA25	RACCORD PTR CAN M	25	1"
CALA26	RACCORD PTR CAN M	30	1"
CALA31	RACCORD PTR CAN M	32	1"1/4
CALA32	RACCORD PTR CAN M	32	1"1/4
CALA33	RACCORD PTR CAN M	40	1"1/4
CALA40	RACCORD PTR CAN M	40	1"1/2
CALA50	RACCORD PTR CAN M	50	2"



RACCORDS A VISSER LAITON

MAMELONS LAITON		G
MMLA08	MAMELON DM	1/4"
MMLA10	MAMELON DM	3/8"
MMLA15	MAMELON DM	1/2"
MMLA20	MAMELON DM	3/4"
MMLA25	MAMELON DM	1"
MMLA32	MAMELON DM	1"1/4
MMLA40	MAMELON DM	1"1/2
MMLA50	MAMELON DM	2"
MMLA10C	MAMELON DM CONIQUE	3/8"C
MMLA15C	MAMELON DM CONIQUE	1/2"C
MMLA20C	MAMELON DM CONIQUE	3/4"C
MMLA25C	MAMELON CHROME CONIQUE	1"C
MMLA32C	MAMELON DM CONIQUE	1"1/4C
MMLA09	MAMELON MM 3/8" - 16x150 gaz	3/8"
RACP1008	MAMELON MM 1/2" - 20x150 gaz	1/2"



REDUCTIONS MÂLE / MÂLE		GM	Gm
RMML08	REDUCTION M/M	1/4"	1/8"
RMML09	REDUCTION M/M	3/8"	1/8"
RMML10	REDUCTION M/M	3/8"	1/4"
RMML14	REDUCTION M/M	1/2"	1/4"
RMML15	REDUCTION M/M	1/2"	3/8"
RMML20	REDUCTION M/M	3/4"	1/2"
RMML25	REDUCTION M/M	1"	3/4"
RMML31	REDUCTION M/M	1"1/4	3/4"
RMML32	REDUCTION M/M	1"1/4	1"
RMML40	REDUCTION M/M	1"1/2	1"1/4
RMML50	REDUCTION M/M	2"	1"1/2



RACCORDS FC 2 PIECES FILETES		G	G
RA2P15	RACCORD PTR M	3/8"	1/2"
RA2P20	RACCORD PTR M	1/2"	3/4"
RA2P25	RACCORD PTR M	3/4"	1"
RA2P32	RACCORD PTR M	1"	1"1/4

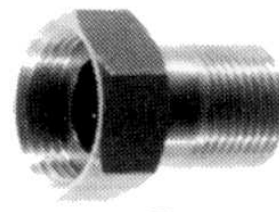

RACCORDS UNION DROIT SPHERIQUE		G
UNDR10	RACCORD UNION DROIT SPHERIQUE MF	3/8"
UNDR15	RACCORD UNION DROIT SPHERIQUE MF	1/2"
UNDR20	RACCORD UNION DROIT SPHERIQUE MF	3/4"
UNDR25	RACCORD UNION DROIT SPHERIQUE MF	1"
UNDR32	RACCORD UNION DROIT SPHERIQUE MF	1"1/4
UNDR40	RACCORD UNION DROIT SPHERIQUE MF	1"1/2
UNDR50	RACCORD UNION DROIT SPHERIQUE MF	2"

RACCORDS UNION DROIT SPHERIQUE		G
UNDR10M	RACCORD UNION DROIT SPHERIQUE MM	3/8"
UNDR15M	RACCORD UNION DROIT SPHERIQUE MM	1/2"
UNDR20M	RACCORD UNION DROIT SPHERIQUE MM	3/4"
UNDR25M	RACCORD UNION DROIT SPHERIQUE MM	1"

RACCORDS COUDES 3 PIECES MF		G
UNCR10	RACCORD COUDES 3 PIECES MF	3/8"
UNCR15	RACCORD COUDES 3 PIECES MF	1/2"
UNCR20	RACCORD COUDES 3 PIECES MF	3/4"
UNCR25	RACCORD COUDES 3 PIECES MF	1"
UNCR32	RACCORD COUDES 3 PIECES MF	1"1/4

REDUCTIONS FEMELLE / MÂLE		GF	GM
R06F10	REDUCTION F/M	1/4"	1/8"
R08F10	REDUCTION F/M	3/8"	1/4"
R08F15	REDUCTION F/M	1/4"	1/2"
R10F15	REDUCTION F/M	1/2"	3/8"
R10F20	REDUCTION F/M	3/4"	3/8"
R15F20	REDUCTION F/M	3/4"	1/2"
R15F25	REDUCTION F/M	1"	1/2"
R20F25	REDUCTION F/M	1"	3/4"
R20F40	REDUCTION F/M	1"1/2	3/4"
R25F32	REDUCTION F/M	1"1/4	1"
R25F40	REDUCTION F/M	1"1/2	1"
R32F40	REDUCTION F/M	1"1/2	1"1/4
R32F50	REDUCTION F/M	2"	1"1/4
R40F50	REDUCTION F/M	2"	1"1/2



REDUCTIONS MÂLE / FEMELLE		GM	GF
RMFL08	REDUCTION M/F	1/4"	1/8"
RMFL10	REDUCTION M/F	3/8"	1/4"
RMFL14	REDUCTION M/F	1/2"	1/4"
RMFL15	REDUCTION M/F	1/2"	3/8"
RMFL18	REDUCTION M/F	3/4"	1/4"
RMFL19	REDUCTION M/F	3/4"	3/8"
RMFL20	REDUCTION M/F	3/4"	1/2"
RMFL24	REDUCTION M/F	1"	1/2"
RMFL25	REDUCTION M/F	1"	3/4"
RMFL31	REDUCTION M/F	1"1/4	3/4"
RMFL32	REDUCTION M/F	1"1/4	1"
RMFL38	REDUCTION M/F	1"1/2	3/4"
RMFL39	REDUCTION M/F	1"1/2	1"
RMFL40	REDUCTION M/F	1"1/2	1"1/4
RMFL50	REDUCTION M/F	2"	1"1/2



MANCHONS		G
MANL08	MANCHON EGAL F/F	1/4"
MANL10	MANCHON EGAL F/F	3/8"
MANL15	MANCHON EGAL F/F	1/2"
MANL20	MANCHON EGAL F/F	3/4"
MANL25	MANCHON EGAL F/F	1"
MANL32	MANCHON EGAL F/F	1"1/4
MANL40	MANCHON EGAL F/F	1"1/2
MANL50	MANCHON EGAL F/F	2"



BOUCHONS FEMELLES		G
BOLA08	BOUCHON LAITON F	1/4"
BOLA10	BOUCHON LAITON F	3/8"
BOLA15	BOUCHON LAITON F	1/2"
BOLA20	BOUCHON LAITON F	3/4"
BOLA25	BOUCHON LAITON F	1"
BOLA32	BOUCHON LAITON F	1"1/4
BOLA40	BOUCHON LAITON F	1"1/2
BOLA50	BOUCHON LAITON F	2"



BOUCHONS MÂLES		G
BOLM08	BOUCHON LAITON M	1/4"
BOLM10	BOUCHON LAITON M	3/8"
BOLM15	BOUCHON LAITON M	1/2"
BOLM20	BOUCHON LAITON M	3/4"
BOLM25	BOUCHON LAITON M	1"
BOLM32	BOUCHON LAITON M	1"1/4
BOLM40	BOUCHON LAITON M	1"1/2
BOLM50	BOUCHON LAITON M	2"



ECROUS A COLLERETTE		G
ECCO10	ECROU A COLLERETTE	3/8"
ECCO15	ECROU A COLLERETTE	1/2"
ECCO15C	ECROU A COLLERETTE CHROMEE D15	1/2"
ECCO20	ECROU A COLLERETTE	3/4"
ECCO25	ECROU A COLLERETTE	1"
ECCO32	ECROU A COLLERETTE	1"1/4
ECCO40	ECROU A COLLERETTE	1"1/2
ECCO50	ECROU A COLLERETTE	2"



ECROUS PLATS		G
ECPL10	ECROU PLAT LAITON	3/8"
ECPL15	ECROU PLAT LAITON	1/2"
ECPL20	ECROU PLAT LAITON	3/4"
ECPL25	ECROU PLAT LAITON	1"
ECPL32	ECROU PLAT LAITON	1"1/4
ECPL40	ECROU PLAT LAITON	1"1/2
ECPL50	ECROU PLAT LAITON	2"



COUDES FEMELLE / FEMELLE		G
CLFF08	COUDE LAITON F/F	1/4"
CLFF10	COUDE LAITON F/F	3/8"
CLFF15	COUDE LAITON F/F	1/2"
CLFF20	COUDE LAITON F/F	3/4"
CLFF25	COUDE LAITON F/F	1"
CLFF32	COUDE LAITON F/F	1"1/4
CLFF40	COUDE LAITON F/F	1"1/2
CLFF50	COUDE LAITON F/F	2"



COUDES MÂLE / MÂLE		G
CLMM08	COUDE LAITON MM	1/4"
CLMM10	COUDE LAITON MM	3/8"
CLMM15	COUDE LAITON MM	1/2"
CLMM20	COUDE LAITON MM	3/4"
CLMM25	COUDE LAITON MM	1"
CLMM32	COUDE LAITON MM	1"1/4
CLMM40	COUDE LAITON MM	1"1/2
CLMM50	COUDE LAITON MM	2"



COUDES MÂLE / FEMELLE EGAUX		G
CLMF08	COUDE LAITON M/F EGAL	1/4"
CLMF10	COUDE LAITON M/F EGAL	3/8"
CLMF15	COUDE LAITON M/F EGAL	1/2"
CLMF20	COUDE LAITON M/F EGAL	3/4"
CLMF25	COUDE LAITON M/F EGAL	1"
CLMF32	COUDE LAITON M/F EGAL	1"1/4
CLMF40	COUDE LAITON M/F EGAL	1"1/2
CLMF50	COUDE LAITON M/F EGAL	2"



TES FEMELLES		G
TELA10	TE LAITON FEMELLE	3/8"
TELA15	TE LAITON FEMELLE	1/2"
TELA20	TE LAITON FEMELLE	3/4"
TELA25	TE LAITON FEMELLE	1"
TELA32	TE LAITON FEMELLE	1"1/4
TELA40	TE LAITON FEMELLE	1"1/2
TELA50	TE LAITON FEMELLE	2"



TES MÂLES		G
TELM10	TE LAITON MÂLE	3/8"
TELM15	TE LAITON MÂLE	1/2"
TELM20	TE LAITON MÂLE	3/4"
TELM25	TE LAITON MÂLE	1"
TELM32	TE LAITON MÂLE	1"1/4
TELM40	TE LAITON MÂLE	1"1/2
TELM50	TE LAITON MÂLE	2"

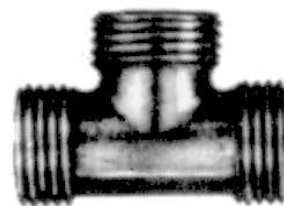

TUBES LAITON FILETE		G
TLAF10	TUBE LAITON FILETE	3/8"
TLAF15	TUBE LAITON FILETE	1/2"
TLAF20	TUBE LAITON FILETE	3/4"
TLAF25	TUBE LAITON FILETE	1"
TLAF32	TUBE LAITON FILETE	1"1/4
TLAF40	TUBE LAITON FILETE	1"1/2
TLAF50	TUBE LAITON FILETE	2"



JONCTIONS ANNELEES LAITON		Ø
JOLA15	RACCORD JONCTION LAITON	15
JOLA20	RACCORD JONCTION LAITON	20
JOLA25	RACCORD JONCTION LAITON	25
JOLA32	RACCORD JONCTION LAITON	32



TES ANNELES LAITON		Ø
TECA05	TE ANNELE	5
TECA06	TE ANNELE	6
TECA08	TE ANNELE	8
TECA10	TE ANNELE	10
TECA12	TE ANNELE	12
TECA15	TE ANNELE	15
TECA20	TE ANNELE	20
TECA26	TE ANNELE	25
TECA32	TE ANNELE	32
TECA40	TE ANNELE	40
TECA50	TE ANNELE	50

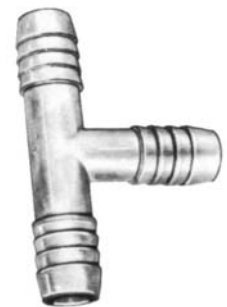

CREPINE DE CALE LAITON		Ø
CRDF20	CREPINE DE CALE LAITON	20
CRDF25	CREPINE DE CALE LAITON	25



CREPINE DE COQUE LAITON		Ø
CR80	CREPINE DE COQUE LAITON	80
CR100	CREPINE DE COQUE LAITON	100

CREPINE DE COQUE BRONZE		Ø
CBZ060	CREPINE DE COQUE BRONZE percée à 50%	60
CBZ080	CREPINE DE COQUE BRONZE percée à 50%	80
CBZ100	CREPINE DE COQUE BRONZE percée à 50%	100
CBZ120	CREPINE DE COQUE BRONZE percée à 50%	120
CBZ140	CREPINE DE COQUE BRONZE percée à 50%	140
CBZ160	CREPINE DE COQUE BRONZE percée à 50%	160
CBZ180	CREPINE DE COQUE BRONZE percée à 50%	180
CBZ200	CREPINE DE COQUE BRONZE percée à 50%	200
CBZ250	CREPINE DE COQUE BRONZE percée à 50%	250

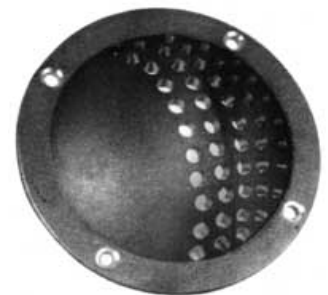

CREPINE SEULE INOX		Ø
CRS200	CREPINE SEULE INOX	60
CRS250	CREPINE SEULE INOX	80
CRS320	CREPINE SEULE INOX	100
CRS400	CREPINE SEULE INOX	120
CRS500	CREPINE SEULE INOX	140

COLLECTEURS LAITON

COLLECTEURS COMPOSABLE		Gs	Ge
COL220	COLLECTEUR COMPOS 2 VOIES	1/2"	3/4"
COL320	COLLECTEUR COMPOS 3 VOIES	1/2"	3/4"
COL420	COLLECTEUR COMPOS 4 VOIES	1/2"	3/4"
COL225	COLLECTEUR COMPOS 2 VOIES	1/2"	1"
COL325	COLLECTEUR COMPOS 3 VOIES	1/2"	1"
COL425	COLLECTEUR COMPOS 4 VOIES	1/2"	1"
COL332	COLLECTEUR COMPOS 2 VOIES	1/2"	1"1/4
COL333	COLLECTEUR COMPOS 3 VOIES	1/2"	1"1/4
COL334	COLLECTEUR COMPOS 4 VOIES	1/2"	1"1/4



COLLECTEURS SIMPLE		Gs	Ge
COL221	COLLECTEUR SIMPLE 2 VOIES	1/2"	3/4"
COL321	COLLECTEUR SIMPLE 3 VOIES	1/2"	3/4"
COL421	COLLECTEUR SIMPLE 4 VOIES	1/2"	3/4"
COL226	COLLECTEUR SIMPLE 2 VOIES	1/2"	1"
COL326	COLLECTEUR SIMPLE 3 VOIES	1/2"	1"
COL426	COLLECTEUR SIMPLE 4 VOIES	1/2"	1"



CLAPETS / CREPINES LAITON

CLAPET A BATTANT BRONZE		G
CLAB10	CLAPET BATTANT DN 10	3/8"
CLAB15	CLAPET BATTANT DN 15	1/2"
CLAB20	CLAPET BATTANT DN 20	3/4"
CLAB25	CLAPET BATTANT DN 25	1"
CLAB32	CLAPET BATTANT DN 32	1"1/4
CLAB40	CLAPET BATTANT DN 40	1"1/2
CLAB50	CLAPET BATTANT DN 50	2"
CLAB60	CLAPET BATTANT DN 60	2"1/2



CLAPET ANTI RETOUR LAITON A RESSORT		G
CLAR10	CLAPET AR DN 10	3/8"
CLAR15	CLAPET AR DN 15	1/2"
CLAR20	CLAPET AR DN 20	3/4"
CLAR25	CLAPET AR DN 25	1"
CLAR32	CLAPET AR DN 32	1"1/4
CLAR40	CLAPET AR DN 40	1"1/2
CLAR50	CLAPET AR DN 50	2"



CLAPET ANTI RETOUR A RESSORT + CREPINE		G
CLAC15	CLAPET CREPINE DN 15	1/2"
CLAC20	CLAPET CREPINE DN 20	3/4"
CLAC25	CLAPET CREPINE DN 25	1"
CLAC32	CLAPET CREPINE DN 32	1"1/4
CLAC40	CLAPET CREPINE DN 40	1"1/2
CLAC50	CLAPET CREPINE DN 50	2"



CLAPET ANTI RETOUR A CREPINE VERTICALE		G
CLVE15	CLAPET CREPINE VE DN15	1/2"
CLVE20	CLAPET CREPINE VE DN 20	3/4"
CLVE25	CLAPET CREPINE VE DN 25	1"
CLVE32	CLAPET CREPINE VE DN 32	1"1/4
CLVE40	CLAPET CREPINE VE DN 40	1"1/2
CLVE50	CLAPET CREPINE VE DN 50	2"



CREPINE LAITON OU INOX NOUS CONSULTER

RACCORDS BICONIQUES

RACCORDS BICONIQUES IMPLANTATION FEMELLE		BIC	G
BF0610	RAC BIC IMP F	6	3/8"
BF0808	RAC BIC IMP F	8	1/4"
BF0810	RAC BIC IMP F	8	3/8"
BF0815	RAC BIC IMP F	8	1/2"
BF1008	RAC BIC IMP F	10	1/4"
BF1010	RAC BIC IMP F	10	1/2"
BF1016	RAC BIC IMP F	16	3/8"



RACCORDS BICONIQUES IMPLANTATION MÂLE		BIC	G
BI0608	RAC BIC IMP M	6	1/4"
BI0610	RAC BIC IMP M	6	3/8"
BI0808	RAC BIC IMP M	8	1/4"
BI0810	RAC BIC IMP M	8	3/8"
BI0815	RAC BIC IMP M	8	1/2"
BI1008	RAC BIC IMP M	10	1/4"
BI1010	RAC BIC IMP M	10	3/8"
BI1015	RAC BIC IMP M	10	1/2"
BI1016	RAC BIC IMP M	16	3/8"
BI1208	RAC BIC IMP M	12	1/4"
BI1210	RAC BIC IMP M	12	3/8"
BI1215	RAC BIC IMP M	12	1/2"
BI1408	RAC BIC IMP M	14	1/4"
BI1410	RAC BIC IMP M	14	3/8"
BI1415	RAC BIC IMP M	14	1/2"
BI1615	RAC BIC IMP M	16	1/2"
BI1820	RAC BIC IMP M	18	3/4"
BI2022	RAC BIC IMP M	22	3/4"



RACCORDS BICONIQUES COUDE EGAUX		BIC
BICC06	RAC BIC COUDE	6
BICC08	RAC BIC COUDE	8
BICC10	RAC BIC COUDE	10
BICC12	RAC BIC COUDE	12
BICC14	RAC BIC COUDE	14
BICC16	RAC BIC COUDE	16



RACCORDS BICONIQUES DROIT		BIC
BICD06	RAC BIC DROIT	6
BICD08	RAC BIC DROIT	8
BICD10	RAC BIC DROIT	10
BICD12	RAC BIC DROIT	12
BICD14	RAC BIC DROIT	14
BICD16	RAC BIC DROIT	16
BICD18	RAC BIC DROIT	18



RACCORDS BICONIQUES REDUIT		BIC	BIC
BICR08	RAC BIC REDUIT	6	8
BICR10	RAC BIC REDUIT	8	10
BICR12	RAC BIC REDUIT	10	12
BICR14	RAC BIC REDUIT	12	14



RACCORDS BICONIQUES TE EGAUX		BIC
BICT06	RAC BIC TE	6
BICT08	RAC BIC TE	8
BICT10	RAC BIC TE	10
BICT12	RAC BIC TE	12
BICT14	RAC BIC TE	14
BICT16	RAC BIC TE	16



OLIVE		BIC
OLIV06	OLIVE	6
OLIV08	OLIVE	8
OLIV10	OLIVE	10
OLIV12	OLIVE	12
OLIV14	OLIVE	14
OLIV16	OLIVE	16
OLIV18	OLIVE	18

RACCORDS PLASTIQUES

RACCORDS Y CANNELES RILSAN		Ø	Ø	Ø
Y08	Raccord Y cannelé rilsan	8	8	8
Y10	Raccord Y cannelé rilsan	10	10	10
Y12	Raccord Y cannelé rilsan	12	12	12
Y14	Raccord Y cannelé rilsan	14	14	14
Y16	Raccord Y cannelé rilsan	16	16	16



RACCORDS en T CANNELES RILSAN		Ø	Ø	Ø
TE12	Raccord Y cannelé rilsan	12	12	12
TE14	Raccord Y cannelé rilsan	14	14	14
TE16	Raccord Y cannelé rilsan	16	16	16
TE20	Raccord Y cannelé rilsan	20	20	20
TE25	Raccord Y cannelé rilsan	25	25	25



RACCORDS REDUIT en T CANNELES RILSAN		Ø	Ø	Ø
TERED2016	Té cannelé rilsan réduit	20	16	20
TERED2516	Té cannelé rilsan réduit	25	16	25
TERED2520	Té cannelé rilsan réduit	25	20	25
TERED3220	Té cannelé rilsan réduit	32	20	32
TERED3225	Té cannelé rilsan réduit	32	25	32
TERED4020	Té cannelé rilsan réduit	40	20	40
TERED4032	Té cannelé rilsan réduit	40	32	40



RACCORD		Ø
HBV32	Soupape évacuation anti-odeur	32
HBV40	Soupape évacuation anti-odeur	40
BV3	Bague de serrage	32
BCV3	Bague de serrage	40
HBV11	Adaptateur articulé	32
HBV1140	Adaptateur articulé	40



BARTOL

PLOMBERIE SANS OUTILS



Gagnez du temps: Installez votre plomberie PB-BARTOL

LES TUYAUX:

- ☞ Résistent au gel (dilatation et retour au diamètre d'origine car le polybutylène est un matériau " à mémoire ")- NB: Laisser environ 500mm entre 2 raccords pour absorber la dilatation.
- ☞ Transportent l'eau chaude et froide sous fortes pressions
16 bars à 20°C, 5 bars à 90°C
- ☞ Ne retiennent pas les dépôts de calcaire
- ☞ Ne sont pas sensibles à la corrosion.
- ☞ Suppriment les bruits de tuyauterie (coups de belier)
- ☞ Sont souples (facilité de pose dans les endroits peu accessibles)
- ☞ Sont légers (facilité de transport)
- ☞ Simples à fixer (colliers et clips)
- ☞ Sont faciles à couper
- ☞ Peuvent être peints
- ☞ Sont repérés pour les coupes
- ☞ Peuvent s'enterrer directement dans le sol

LES RACCORDS:

- ☞ Jonction par simple emboitement (plus de soudure ni de colle)
- ☞ Gain sur les temps de montage de l'ordre de 50% par rapport à de la tuyauterie traditionnelle
- ☞ Sont démontables (idéal en cas de pose provisoire ou de modification d'installation)
- ☞ Propres à installer (pas de colle)
- ☞ Possibilité de mettre des branchements en attente
- ☞ Possibilité de raccordements sur des installations existantes

UTILISER LE SYSTEME BARTOL C'EST SE SIMPLIFIER LA VIE ...

TUYAUX système BARTOL

TUYAUX EN POLYBUTYLENE en barre			Ø
HCP03/15	BARRE	Lg: 3 m	15
HCP06/15	BARRE	Lg: 6 m	15
HCP03/22	BARRE	Lg: 3 m	22
HCP06/22	BARRE	Lg: 6 m	22



TUYAUX EN POLYBUTYLENE en Couronne			Ø
HCP25/15	COURONNE	Lg: 25 m	15
HCP50/15	COURONNE	Lg: 50 m	15
HCP100/15	COURONNE	Lg: 100 m	15
HCP25/22	COURONNE	Lg: 25 m	22
HCP50/22	COURONNE	Lg: 50 m	22



TUYAUX POLYETHYLENE			Ø
TUPLOYB/15	COURONNE TUYAU BLEU	Lg:100m	15
TUPLOYR/15	COURONNE TUYAU ROUGE	Lg:100	15

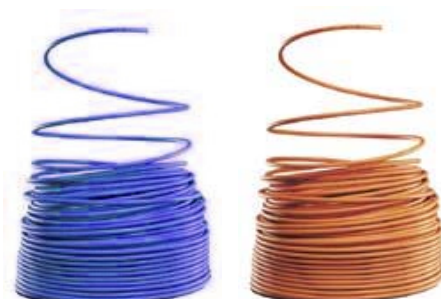

rayon de courbure Ø15 : R:180

Rayon de courbure Ø22 : R:300 mm

RACCORDS système BARTOL

ADAPTATEUR FILETE LAITON

		G	Ø
HC28/15	DROIT FEMELLE 15/21	1/2"	15
HC 24/15	DROIT FEMELLE 20/27	3/4"	15
HC28/22	DROIT FEMELLE 20/27	3/4"	22
HX28/28	DROIT FEMELLE 26/34	1"	28



		G	Ø
HC29/15	DROIT MÂLE 15/21	1/2"	15
HC29/22	DROIT MÂLE 20/27	3/4"	22
HX29/28	DROIT MÂLE 26/34	1"	28



		G	Ø
HC25/15A	DROIT LONG FEMELLE 15/21	1/2"	15
HC25/15B	DROIT LONG FEMELLE 20/27	3/4"	15
HC 25/22	DROIT LONG FEMELLE 20/27	3/4"	22



		G	Ø
HC1/27X15	COUDE FEMELLE 15/21	1/2"	15



ADAPTATEUR FILETE LAITON à emboiter sur raccord BARTOL

		G	Ø
HC30/15	DROIT FEMELLE 15/21	1/2"	15
HC30/22	DROIT FEMELLE 20/27	3/4"	22
HX30/28	DROIT FEMELLE 26/34	1"	28



		G	Ø
HC31/15	DROIT MÂLE 15/21	1/2"	15
HC31/22	DROIT MÂLE 20/27	3/4"	22
HX31/28	DROIT MÂLE 26/34	1"	28



RACCORDS LAITON

		G	G
HC 39/15	REDUCTEUR M/F 3/8" / 1/2"	3/8"	1/2"



		Ø	Ø
HC 32/15	ROBINET DE VIDANGE Ø 15	15	15



RACCORDS BARTOL

		Ø	Ø
HC1/15	MANCHON DROIT Ø 15	15	15
HC1/22	MANCHON DROIT Ø 22	22	22
HD1/28	MANCHON DROIT Ø 28	28	28
HC1/16	MANCHON DROIT Ø 15 / Ø 16	15	16



		Ø	Ø
HC5/15	COUDE 90° Ø 15	15	15
HC5/22	COUDE 90° Ø 22	22	22
HD5/28	COUDE 90° Ø 28	28	28



		Ø	Ø
HC10/15	RACCORD Té Dia. 15	15	15
HC10/22	RACCORD Té Dia. 22	22	22
HD 10/28	RACCORD Té Dia. 28	28	28



		Ø	G
HC20/15	RACCORD pour réservoir Ø 15	15	1/2"
HC20/22	RACCORD pour réservoir Ø 22	22	3/4"



		Ø	G
HC6/15	APPLIQUE pour robinet Bartol	15	1/2"
HC6/22	APPLIQUE pour robinet Bartol	22	3/4"



		Ø	Ø
HC21510	REDUCTEUR DROIT 15 X 10	15	10
HC22215	REDUCTEUR DROIT 22 X 15	22	15
HD22822	REDUCTEUR DROIT 28 X 22	28	22



		Ø	Ø	Ø
HC12/2215	REDUCTEUR "T" 22 X 22 X 15	22	22	15
HD12/28	REDUCTEUR "T" 28 X 28 X 28	28	28	22



		Ø	Ø	Ø
HC 13/15	REDUCTEUR "T" 15 X 10 X 15	15	10	15
HC 13/22	REDUCTEUR "T" 22 X 15 X 22	22	15	22
HD 13/28	REDUCTEUR "T" 28 X 22 X 28	28	22	28



		Ø	Ø	Ø
HC14/2215	REDUCTEUR "T" 22 X 15 X 15	22	15	15
HD14/28	REDUCTEUR "T" 28 X 22 X 22	28	22	22



		Ø	Ø	Ø
HC13/2215	REDUCTEUR "T" 22 X 15 X 22	22	15	22



ROBINETS Coupures BARTOL

		Ø	Ø
HC36/15	ROBINET d'arrêt eau froide Ø 15	15	15
HC36/22	ROBINET d'arrêt eau froide Ø 22	22	22



		Ø	Ø
HC37H	ROBINET 1/4 tour eau chaude	15	15
HC37C	ROBINET 1/4 tour eau froide	15	15



		Ø	G
HC38H	ROBINET 1/4 tour eau chaude	15	3/4"
HC38C	ROBINET 1/4 tour eau froide	15	3/4"



		Ø	Ø
HX72/15	CLAPET ANTI - RETOUR	15	15
HX72/22	CLAPET ANTI - RETOUR	22	22



COLLECTEURS système BARTOL

Les collecteurs BARTOL peuvent véhiculer de l'eau chaude ou froide

Ils permettent de réaliser la distribution d'eau avec ou sans possibilité d'isoler une partie du réseau

Collecteur équipé de robinet sur chaque sortie

		Ø ent.	Ø sort.
HM 662/15	COLLECTEUR 2 SORTIES	3/4"	15
HM 663/15	COLLECTEUR 3 SORTIES	3/4"	15
HM 664/15	COLLECTEUR 4 SORTIES	3/4"	15

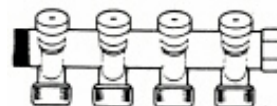

ACCESSOIRES système BARTOL

		Ø	Paquet de
HC60/15	FOURRURE INOX Ø 15	15	50
PEFOU 15	FOURRURE PLASTIQUE Ø 15	15	50
HC60/22	FOURRURE INOX Ø 22	22	50
HC60/28	FOURRURE INOX Ø 28	28	50



		Ø	Paquet de
HC65/15	CAVALIER Ø 15	15	50
HC65/22	CAVALIER Ø 22	22	50



		Ø	Paquet de
HC85/15	ATTACHE TYPE CLIPS	15	50
HC85/22	ATTACHE TYPE CLIPS	22	50



		Ø	Paquet de
HC86/15	REHAUSSE POUR ATTACHE	15	50
HC86/22	REHAUSSE POUR ATTACHE	22	50



		Ø	Paquet de
HC 79/15	OUTIL EXTRACTEUR	15	10
HC 79/22	OUTIL EXTRACTEUR	22	10



		Ø	Paquet de
HC 51/15	JOINTS TORIQUES	15	20
HC 51/22	JOINTS TORIQUES	22	20



		Ø
HC75/15	ANGLE POUR TUYAU Dia. 15	15
HC75/22	ANGLE POUR TUYAU Dia. 22	22



HC74	PINCE TRCHANTE
------	----------------



		Poids
S254	LUBRIFIANT SILICONE	125g



RACCORDS TUYAUX D'ARROSAGE

		Ø
HO 2182	Raccord robinet femelle	1/2"
HO 2167	Raccord robinet femelle	3/4"
HO 2158	Raccord robinet femelle	1"



		Ø
HO 2182	Raccord robinet mâle	3/4"



HO 2291	Coupleur	
---------	----------	--



		Ø
HO 2166	Raccord tuyau	15
HO 2266	Raccord tuyau	19



HO 2292	Lance d'arrosage	
HO 2665	Pistolet d'arrosage	
HO 6620	Range tuyau 20m	



		Ø
RACAQUA	Raccord rapide AQUASTOP 20x27	3/4"
RADA15	Adaptateur Mâle AQUASTOP 15x21	1/2"

POMPES

AQJET312V	POMPE AQUA JET 3.4 12 VOLTS
AQUJET324	POMPE AQUA JET 3.4 24 VOLTS
AQUJET5.12LAV	POMPE AQUA JET LAVAGE 5.0 12V
AQUJET5.24LAV	POMPE AQUA JET LAVAGE 5.0 24V
AQUJET512	POMPE AQUA JET 5 12 VOLTS.
AQUJET524	POMPE AQUA JET 5 24 VOLTS
AQUNO5.12	AQUA JET WPS UNO 5.0 12 V
AQUNO5.24	AQUA JET WPS UNO 5.0 24 V
AQUNO3.12	AQUA JET WPS UNO 3.4 24 V
AQUAJETWPS10	AQUA JET DUO 10. 24V WPS



F3B19	ELECTROPOMPE JOHNSON F3B19 12V
F3B1924V	ELECTROPOMPE JOHNSON F3B19 24V
EMBRE12CC	EMBRAYAGE ELECTRO 12 VOLTS 1 G
EMBRE24CC	EMBRAYAGE ELECTROMA 1 GORGE 24 VOLTS
F2P10	ELECTROPOMPE JOHNSON F2P10
F35B8	POMPE F 35 B 8



		litre
RESINOX	Vase d'expansion inox à membrane	20
VAS100	Vase d'expansion à membrane	1
VAS627	Vase d'expansion à membrane	5
VAS525	Vase d'expansion à membrane	8
VAS551	Vase d'expansion à membrane	20

BACDOUCHE	BAC D'ASSECHEMENT POUR DOUCHE
BRASSEUR	BRASSEUR D'EAU CO30P5



F5B1912V	POMPE F5 B19 12 VOLTS
F7B50001	POMPE EMBRAYAGE F7 B5001
F7B8	POMPE F 7 B 8
F7B9	POMPE F7 B3000-1
F8B5001	POMPE EMBRAYAGE F8B50001
F8B8	POMPE F8B8
F8CO	CORPS DE POMPE F8
F9B5000	POMPE F9B5000 SS EMB
GREAU24V	GROUPE EAU 24 V 25 L/M
L12012V	POMPE IMMERGEE 18 2 V



PO541	POMPE POULIE SANS EMBR.DN 25
PO541.1	POMPE POULIE AVEC EMBR DN25
PO542	POMPE POULIE SANS EMBR DN30
PO544	POMPE POULIE AVEC EMB.DN40
PO545.	POMPE 545 EMBRAYAGE DN50
PO545EMB	POMPE 545.5 AVEC EMBRAYAGE DN50



L160012V	POMPE de CALE L1600 12 VOLTS
L160024V	POMPE DE CALE L1600 24 VOLTS
L220012V	POMPE DE CALE L2200 12 VOLTS
L220024V	POMPE DE CALE L 2200 24 VOLTS
L350	POMPE IMMERGEE L350 12 VOLTS
L450	POMPE IMMERGEE L450 12 VOLTS
L550	POMPE IMMERGEE L 550 12 VOLTS
L550DUO	POMPE IMMERGEE /CONTACT L550
L650	POMPE IMMERGEE L 650 12 VOLTS
L750	POMPE IMMERGEE L750 12 VOLTS
L750DUO	POMPE IMMERGEE/CONTACT L750



P12012V	GROUPE POMPE S/S PRESSION 12V
P12024V	GROUPE POMPE S/S PRESSION 24 VOLTS



P7512V	POMPE P75 12 VOLTS
P7524V	POMPE P75 24 VOLTS



PO6102	POMPE A ENGRENAGE marco 12 VOLTS
PO6103	POMPE A ENGRENAGE marco 24 VOLTS
PO6112	POMPE A ENGRENAGE 12 VOLTS
PO6113	POMPE A ENGRENAGE 24 VOLTS
PO6132	POMPE A ENGRENAGE 12 VOLTS 12 l/h



PO615212	POMPE INOX 12 VOLTS
PO6153	POMPE INOX 24 VOLTS



POCALE12V	POMPE DE CALE ET VIDANGE WC12 NOIRE
POCALE24V	POMPE DE CALE ET VIDANGE WC 24 V NOIRE

POCO90	POMPE DE CIRCULATION CO90 24V
POCO9012V	POMPE DE CIRCULATION CO 90 12V



POMATE	POMPE IMMERGEE FIRST MATE 12V
--------	-------------------------------

PPEBULKHEAD	POMPE A MAIN BULHEAD
PPETHRUDECK	POMPE A MAIN PASSE PONT1"
PPETHRUDECK1	POMPE/CALE VIKING PASSE PONT 1".1/2

PO2012	POMPE MARINA 20 12 VOLTS
PO2024	POMPE MARINA 20 24 VOLTS

POBN2	POMPE BE M-20 220 VOLTS
-------	-------------------------

POFUEL24	POMPE FUEL CC 24 VOLTS
----------	------------------------

10017.GROTEL2	GRUPE HYDROPHOR 24 VOLTS
	POMPE HYDROPHORE BZ 24 VOLTS
POMCA80	POMPE AUTOAMORCANTE BZ TRI

POCOMPAC	POMPE COMPAC 50
POGUSHER	POMPE A PIED GUSHER 05
PO125N	POMPE A PIED

POCHIMP	POMPE CHIMP MK III A LEVIER
POHEN1	POMPE HENDERSON SIMPLE EFFET
POHEN2	POMPE HENDERSON DOUBLE EFFET
POHEPA	PASSAGE DE CLOISON HENDERSON



POMDOU2.4	POMPE MEMBRANE DOUBLE EFFET 2.4
POMSII.2	POMPE A MEMBRANE SIMPLE EFFET 1.2



BALLON	BALLON KIT HYDROPHORE
--------	-----------------------

AS888	CONTACTEUR DE NIVEAU
CONTELEC1	CONTACTEUR EL ECTRONIQUE 12v

PRES120	PRESSIOSTAT GROUPE P120
PRES50/75	KIT PRESSIOSTAT P50/75
PRESAQUA5.1	PRESSIOSTAT POMPE UNO 5. 0 24V

TUYAUX

ASPIRATION

Tuyau Garden Spirale PVC qualité alimentaire		Ø int	Ø ext
GARDE13	TUYAU GARDEN	13	18
GARDE15	TUYAU GARDEN	15	20
GARDE20	TUYAU GARDEN	20	26
GARDE25	TUYAU GARDEN	25	31
GARDE30	TUYAU GARDEN	30	36
GARDE32	TUYAU GARDEN	32	37
GARDE35	TUYAU GARDEN	35	41
GARDE38	TUYAU GARDEN	38	44
GARDE40	TUYAU GARDEN	40	46
GARDE50	TUYAU GARDEN	50	60
GARDE60	TUYAU GARDEN	60	70
GARDEN80	TUYAU GARDEN	80	90



Tuyau Springvin Spirale acier qualité alimentaire		Ø int	Ø ext
TUSPRIN13	TUYAU SPRINGVIN	13	20
TUSPRIN16	TUYAU SPRINGVIN	16	23
TUSPRIN20	TUYAU SPRINGVIN	20	27
TUSPRIN25	TUYAU SPRINGVIN	25	32
TUSPRIN30	TUYAU SPRINGVIN	30	37
TUSPRIN32	TUYAU SPRINGVIN	32	39
TUSPRIN38	TUYAU SPRINGVIN	38	46
TUSPRIN40	TUYAU SPRINGVIN	40	49
TUSPRIN45	TUYAU SPRINGVIN	45	55
TUSPRIN51	TUYAU SPRINGVIN	51	62



TUSPRIB20	TUYAU SPRINGVIN BLANC	20	27
-----------	-----------------------	----	----

DISTRIBUTION EAU DOUCE SOUS PRESSION

Tuyau sodi-tress qualité alimentaire		Ø int	Ø ext
SODI04	TUYAU SODITRESS	4	10
SODI06	TUYAU SODITRESS	6	12
SODI08	TUYAU SODITRESS	8	14
SODI10	TUYAU SODITRESS	10	16
SODI12	TUYAU SODITRESS	12	18
SODI16	TUYAU SODITRESS	16	22
SODI19	TUYAU SODITRESS	19	26
SODI25	TUYAU SODITRESS	25	33
SODI30	TUYAU SODITRESS	30	38
SODI32	TUYAU SODITRESS	32	42
SODI38	TUYAU SODITRESS	38	48
SODI40	TUYAU SODITRESS	40	52
SODI50	TUYAU SODITRESS	50	62



CIRCULATION EAU CHAUDE (130°)

Tuyau thermidor		Ø
TUTH12	TUYAU TYPE THERMIDOR 12	12
TUTH15	TUYAU TYPE THERMIDOR DN15	15
TUTH19	TUYAU TYPE THERMIDOR DN19	19
TUTH25	TUYAU TYPE THERMIDOR DN 25	25



SPECIAL COMPARTIMENT MOTEUR (normes affaires maritimes)

Tuyau Flamme (tenue au feu 800°c renfort fibre de verre)		Ø
FLAM10V25	TUYAU FLAMME 10 V 25	25
FLAM10V30	TUYAU FLAMME 10 V 30	30
FLAM10V32	TUYAU FLAMME 10 V 32	32
FLAM10V40	TUYAU FLAMME 10 V 40	40



ECHAPPEMENT MOTEUR

Tuyau Spécial échappement (ISO 7840)		Ø
TUECHAPP40	TUYAU SPECIAL ECHAPPEMENT	40
TUECHAPP45	TUYAU SPECIAL ECHAPPEMENT	45
TUECHAPP51	TUYAU SPECIAL ECHAPPEMENT	51
TUECHAPP63	TUYAU SPECIAL ECHAPPEMENT	63
TUECHAPP76	TUYAU SPECIAL ECHAPPEMENT	76
TUECHAPP90	TUYAU SPECIAL ECHAPPEMENT	90
TUECHAPP102	TUYAU SPECIAL ECHAPPEMENT	102



REPLISSAGE GAS OIL

Tuyau Remplissage Gasoil (ISO 7840)		Ø
TUREMP38	TUYAU REPLISSAGE GAS OIL 38	38
TUREMP51	TUYAU REPLISSAGE GAS OIL 51	51



CARBURANT

Tuyau carburant (ISO 7840)		Ø
TUMA08	TUYAU CARBURANT ISO 7840	8
TUMA10	TUYAU CARBURANT ISO 7840	10
TUMA12	TUYAU CARBURANT ISO 7840	12
TUMA13	TUYAU CARBURANT ISO 7840	13
TUMA15	TUYAU CARBURANT ISO 7840	15
TUMA19	TUYAU CARBURANT ISO 7840	19
TUMA20	TUYAU CARBURANT ISO 7840	20



EAUX NOIRES

Tuyau sodispire (caoutchouc toilé, anti odeur) pour Holding Tanc		Ø
TUDISPI38	TUYAU SODISPIR NOIR	38
TUDISPI50	TUYAU SODISPIR NOIR	50
TUDISPI60	TUYAU SODISPIR NOIR	60



Tuyau médium blanc anti odeur pour WC		Ø
TUMEDIB20	TUYAU MEDIUM BLANC	20
TUMEDIB25	TUYAU MEDIUM BLANC	25
TUMEDIB38	TUYAU MEDIUM BLANC	38
TUMEDIB51	TUYAU MEDIUM BLANC	51



Tuyau Butyl blanc spécial sanitaire Garantie spécial sans odeur		Ø
BUTYL25	TUYAU BUTYL SANITAIRE BLANC	20
BUTYL38	TUYAU BUTYL SANITAIRE BLANC	38
BUTYL50	TUYAU BUTYL SANITAIRE BLANC	50
BUTYL60	TUYAU BUTYL SANITAIRE BLANC	60



VENTILATION

Gaine de ventilation		Ø
TUAIR102	TUYAU AIR SIB	102
TUAIRFL40	TUYAU AIRFLEX	40
TUAIRFL51	TUYAU AIRFLEX	51
AIRFLEX76	GAINE PVC 76 AIRFLEX	76



ARROSAGE

Tuyau renforcé Canari		Ø
TUCANA15	TUYAU CANARI	15
TUCANA19	TUYAU CANARI	19
TUCANA30	TUYAU CANARI	30



TUYAUX DIVERS

Tuyau transparent Sodi Clair		Ø
SODICL06	TUYAU SODI CLAIR	6
SODICL08	TUYAU SODI CLAIR	8
SODICL10	TUYAU SODI CLAIR	10
SODICL12	TUYAU SODI-CLAIR	12



Tuyau spécial Piscine		Ø
TUPI38	TUYAU PISCINE DN 38	38



Flexible inox		Ø
FL15/15FF	Flexible inox lg:500 mm FF	1/2"
FL15/15MF	Flexible inox lg:500 mm MF	1/2"
FL20/20FF	Flexible inox lg:500 mm FF	3/4"



POT D'ÉCHAPPEMENT - WATERLOCK

Waterlock		Ø
VEWAT40	Waterlock LP40	40
VEWAT45	Waterlock LP45	45
VEWAT50	Waterlock LP50	50
VEWATS50	Waterlock LP50S	50
VEWAT60	Waterlock LP60	60
VEWAT75	Waterlock LP75	75
VEWAT90	Waterlock LP90	90



Waterlock		Ø
VEWAN45	Waterlock NLP45	45
VEWAN50	Waterlock NLP50	50
VEWANS50	Waterlock NLP50S	50
VEWAN60	Waterlock NLP60	60
VEWAN75	Waterlock NLP75	75
VEWAN90	Waterlock NLP90	90



Pot d'échappement, barboteur		Ø	Ø	Ø
BARBO 08	Barboteur 8l	45	50	60
BARBO 9,5	Barboteur 9l	50	60	75
BARBO 20L	Barboteur 20l		90	100

Coude		Ø
VECOEC40	Coude échappement	40
VECOEC45	Coude échappement	45
VECOEC50	Coude échappement	50
VECOEC75	Coude échappement	75

Col de cygne échappement		Ø
VECOCY40	Col de cygne échappement	40
VECOCY45	Col de cygne échappement	45
VECOCY50	Col de cygne échappement	50
VECOCY60	Col de cygne échappement	60

Coude anti-siphon		Ø
VEANSICL	Coude anti siphon à clapet	13 à 32
VEANSPRI	Coude anti siphon à mise à l'air libre	13 à 32

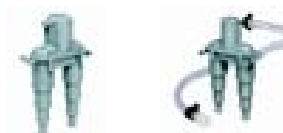

Manchon réducteur pla		Ø
VERED3060	Manchon réducteur	30 à 60
VERED1338	Manchon réducteur	13 à 38



COLLIERS

Collier de serrage Echappement inox 316		Ø tuyau	Ø	Ø
COLMA44-47	COLLIERS SERRAGE INOX		44	47
COLMA48-51	COLLIERS SERRAGE INOX	40	48	51
COLMA52-55	COLLIERS SERRAGE INOX	45	52	55
COLMA56-59	COLLIERS SERRAGE INOX	50	56	59
COLMA60-63	COLLIERS SERRAGE INOX		60	63
COLMA68-73	COLLIERS SERRAGE INOX		68	73
COLMA74-79	COLLIERS SERRAGE INOX		74	79
COLMA80-85	COLLIERS SERRAGE INOX	76	80	85
COLMA86-91	COLLIERS SERRAGE INOX		86	91
COLMA92-97	COLLIERS SERRAGE INOX		92	97
COLMA98-103	COLLIERS SERRAGE INOX	90	98	103
COLMA104-112	COLLIERS SERRAGE INOX	102	104	112
COLMA113-121	COLLIERS SERRAGE INOX		113	121
COLMA122-130	COLLIERS SERRAGE INOX		122	130
COLMA131-139	COLLIERS SERRAGE INOX	127	131	139
COLMA149-161	COLLIERS SERRAGE INOX		149	161



Collier inox W4		Ø	Ø
MPC8-16	collier inox W4 tete fixe 8/16	8	16
MPC12-20	collier inox W4 tete fixe 12/20	12	20
MPC16-25	collier inox W4 tete fixe 16/27	16	25
MPC20-32	collier inox W4 tete fixe 20/32	20	32
MPC25-40	collier inox W4 tete fixe	25	40
MPC32-50	collier inox W4 tete fixe 32/50	32	50
MPC40-60	collier inox W4 tete fixe	40	60
MPC50-70	collier inox W4 tete fixe	50	70
MPC60-80	collier inox W4 tete fixe	60	80
MPC70-90	collier inox W4 tete fixe	70	90

Collier Hopinox inox 316		Ø	Ø
SER08-12	COLLIER HOPINOX 8M	8	12
SER08-16	COLLIER HOPINOX 8 M	8	16
SER12-22	COLLIER HOPINOX 8M	12	22

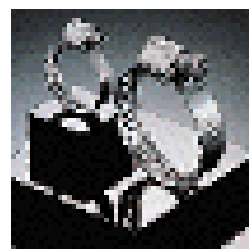

Collier Nemiox inox 316		Ø	Ø
SER16-27	COLLIER NEMIOX 8M	16	27
SER20-35	COLLIER NEMIOX 8M	20	35
SER20-40	COLLIER NEMIOX 8M	20	40
SER30-50	COLLIER NEMIOX 8M	30	50
SER30-60	COLLIER NEMIOX 8M	30	60
SER40-70	COLLIER NEMIOX 8M	40	70
SER40-80	COLLIER NEMIOX 8M	40	80
SER40-90	COLLIER NEMIOX 8M	40	90
SER60-115	COLLIER NEMIOX 8M	60	115
SER60-215	COLLIER NEMIOX 8M	60	215
125	COLLIER NEMIOX 9 M	60	125



Collier inox éco		Ø	Ø
ECO10-18	COLLIER BANDE INOX 8M	10	18
ECO12-22	COLLIER BANDE INOX 8M	12	22
ECO16-27	COLLIER BANDE INOX 8M	16	27
ECO23-35	COLLIER BANDE INOX 8M	23	35
ECO30-45	COLLIER BANDE INOX 9M	30	45
ECO32-50	COLLIER BANDE INOX 9M	32	50
ECO40-60	COLLIER BANDE INOX 9M	40	60
ECO50-70	COLLIER BANDE INOX 9M	50	70
ECO60-80	COLLIER BANDE INOX 9M	60	80
ECO70-90	COLLIER BANDE INOX 9M	70	90



Collier PVC		Ø
COPVC32	COLLIER PVC RIGIDE	32
COPVC40	COLLIER PVC RIGIDE	40
COPVCC50	COLLIER PVC RIGIDE	50



FILTRES EAU DE MER

Filtres Mediterraneo (couvercle bronze, existe avec couvercle polycarbonate)		G
FIMED10	FILTRE MEDITERRANEO	3/8"
FIMED15	FILTRE MEDITERRANEO	1/2"
FIMED20	FILTRE MEDITERRANEO	3/4"
FIMED25	FILTRE MEDITERRANEO	1"
FIMED32	FILTRE MEDITERRANEO	1"1/4
FIMED40	FILTRE MEDITERRANEO	1"1/2
FIMED50	FILTRE MEDITERRANEO	2"
FIMED65	FILTRE MEDITERRANEO	2"1/2
FIMED80	FILTRE MEDITERRANEO	3"
FIMED100	FILTRE MEDITERRANEO	4"



Filtres Iono (couvercle bronze, existe avec couvercle polycarbonate)		G
FIION20	FILTRE IONO	3/4"
FIION25	FILTRE IONO	1"
FIION32	FILTRE IONO	1"1/4
FIION40	FILTRE IONO	1"1/2
FIION50	FILTRE IONO	2"
FIION65	FILTRE IONO	2"1/2
FIION80	FILTRE IONO	3"



Filtre Atlantico (couvercle bronze, existe avec couvercle polycarbonate)		G
FIATL80	FILTRE ATLANTICO	3"



FILTRE A EAU PLASTIQUE		Ø
VEFI 14013	Filtre à eau type 140	13
VEFI 14016	Filtre à eau type 140	16
VEFI 140	Filtre à eau type 140	19
VEFIL 3316	Filtre à eau type 330	16
VEFIL 330	Filtre à eau type 330	19
VEFIL 3325	Filtre à eau type 330	25
VEFIL 3332	Filtre à eau type 330	32
VEFIL 3338	Filtre à eau type 330	38
VEFIL1320	Filtre à eau type 1320	38
VEFTR14	Panier pour filtre type 140	
VEFTR05	Panier pour filtre type 300	



FILTRE ANTI-ODEUR		Ø
VEAO	Filtre anti odeur	16
VEAO 25	Filtre anti odeur	25



NABLES DE PONT

Nable Gasoil		Ø
NABLEG	NABLE GASOIL PP	50
NABLEGAL	NABLE GASOIL ALU	50

Nable eau douce		Ø
NABLEW	NABLE EAU PP	35
NABLEWAL	NABLE EAU ALU	35

Nable eaux grises		Ø
NABLEWPP	NABLE WASTE PP	40
NABLEWSAL	NABLE WASTE ALU	40



LE GAZ

DETENDEUR	
DETENBUTANE	DETENDEUR BUTANE 28mm BARS
DETENBUTN	DETENDEUR BUTANE A VISSER
DETENMANO	DETENDEUR MANOMETRIQUE
DETENPRON	DETENDEUR PROPANE A VISSER
DETENCAM	DETENDEUR CAMPING GAZ NORME



FLEXIBLE	
FLEINO100	FLEXIBLE INOX 1 m GAZ BRUT ET PROP
FLENOR50	FLEXIBLE NORME NF 1/2 -20 - 0.5 M
FLENOR75	FLEXIBLE NORME NF 1/2 -20 - 0.75 M
FLENOR100	FLEXIBLE NORME NF 1/2 -20 - 1.0 M
FLENOR150	FLEXIBLE NORME NF 1/2 -20 - 1.5 M
FLENOR200	FLEXIBLE NORME NF 1/2 -20 - 2.0 M



RACCORD	
RACINTER	RACCORD INTERNATIONAL GAZ



MULTI-VANNES	
V822	MULTI VANNE GAZ 3 VOIES
V842	MULTIVANNES 2 VOIES 20/150



TUYAU CUIVRE		Ø
TUCR06	TUBE CUIVRE /6	6
TUCR08	TUBE CUIVRE RECUIT /8	8
TUCR10	TUBE CUIVRE RECUIT /10	10
TUCR12	TUBE CUIVRE RECUIT /12	12
TUCR14	TUBE CUIVRE RECUIT /14	14
TUCR16	TUBE CUIVRE RECUIT /16	16
TUCR18	TUBE CUIVRE RECUIT /18	18
TUCR20	TUBE CUIVRE RECUIT /20	20



LES RESERVOIRS

RESERVOIR A EAU		L
RESSOU60	Réservoir souple 60l rectangulaire	60
RESSOU100	Réservoir souple 100l rectangulaire	100
RESSOU150	Réservoir souple 150l rectangulaire	150

RESERVOIR FUEL		L
RESGO30	Réservoir rectangulaire	30
RESGO90	Réservoir rectangulaire	90
VEKITA	Kit installation réservoir gasoil	



HOLDING TANK		L
RES30	Holding tanck rectangulaire	30
RES60	Holding tanck rectangulaire	60
RES80	Holding tanck rectangulaire	80
RES100	Holding tanck rectangulaire	100
HOL85	Holding tanck vertical équipé	85
HOLD50L	Holding tanck vertical équipé	50



		Ø
RACOUD	Raccord dessalinisateur sur réservoir	1/2"
RACDR	Raccord droit réservoir eau	1"1/2
EVENT	Event droit chromé	1/2"
EVENTCOU	Event coudé chromé	19
EVENTDR	Event droit chromé	19
10063.EVENT	Event droit plastique blanc	
10063.EVENCO	Event coudé plastique blanc	

